

Smart Surface Box 115 GI for 1L

128000XX_128001XX_128002XX

1

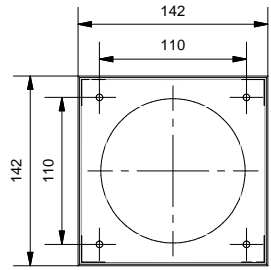

2

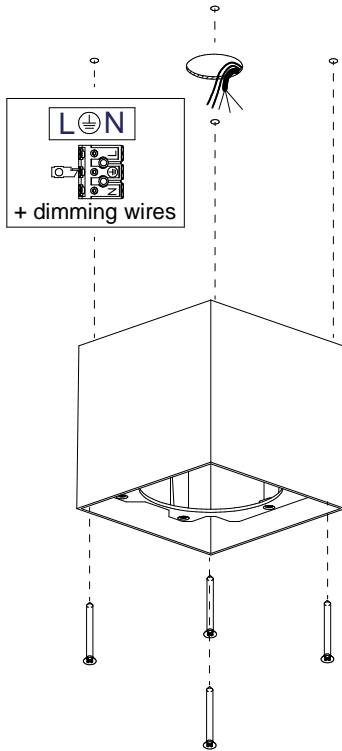

SMART 115 GE and MASK not included

3

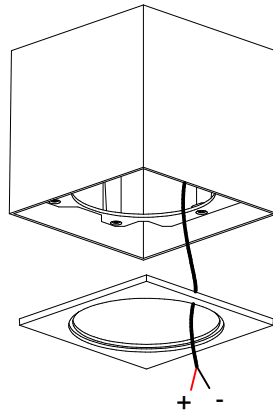

4

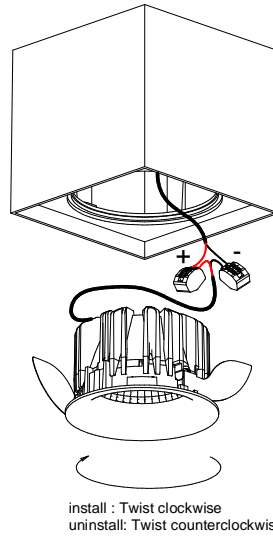

5

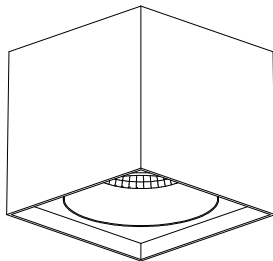

Sample 1-10V wiring diagram:

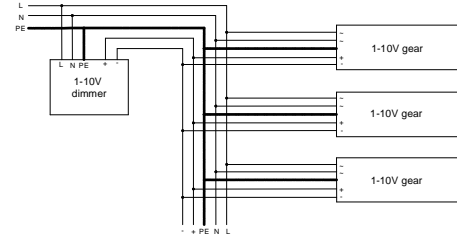

Sample PushDim wiring diagram:

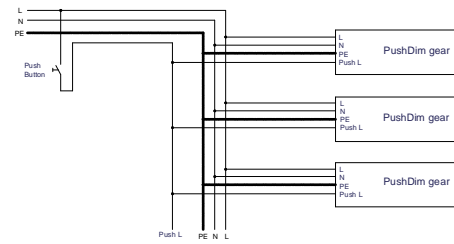

Sample DALI wiring diagram:

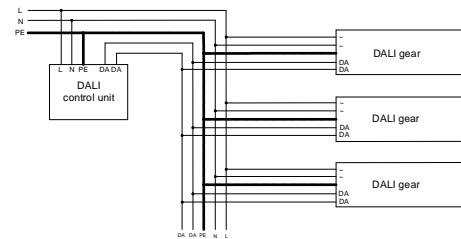

MUST BE USED WITH

- 128100xx - Smart mask ø115 1x
- 127410xx - Smart Cake Ø115 GE
- 127420xx - Smart Cake Ø115 IP54 GE*
- 127430xx - Smart Cake Ø115 IP54 DIF GE*
- 127510xx - Smart Lotis Ø115 GE
- 127520xx - Smart Lotis Ø115 IP54 GE*
- 127530xx - Smart Lotis Ø115 IP54 DIF GE*
- 127610xx - Smart Kup Ø115 GE
- 127620xx - Smart Kup Ø115 IP54 GE*
- 127630xx - Smart Kup Ø115 IP54 DIF GE*
- 127710xx - Smart Cake adjustable Ø115 LED
- 127810xx - Smart Lotis adjustable Ø115 LED
- 127910xx - Smart Kup adjustable Ø115 LED

* in combination with Surface Box = IP20 16/012017 v1

	230V / 50-60Hz		